

MAGDALENA KRAUZE^{*)}, JERZY TRZESZCZYŃSKI, MAŁGORZATA DZIĘCIOŁ

Technical University of Szczecin
 Institute of Organic Chemical Technology
 Al. Piastów 42, 71-065 Szczecin, Poland

The influence of temperature and the kind of the atmosphere on polystyrene thermal degradation

Summary — The influences of atmosphere and sample heating rate on the degradation temperature were estimated. Thermal degradation of polystyrene (PS) was carried out in a flow tubular furnace under isothermal conditions and in a thermogravimetric analyser under dynamic conditions. The experiments were performed in both a nitrogen and an air atmosphere. The thermal behaviour of tested polymer was determined on the basis of the thermogravimetric curves. The process of polystyrene thermal degradation in the tubular furnace was studied at the temperatures of 300°C, 400°C, 500°C, and 600°C for 30 min. The volatile and less-volatile thermal degradation products were analyzed using gas chromatography — mass spectrometry (GC-MS) and Fourier transform infrared spectroscopy (FT-IR) methods. 64 degradation products were identified. Main of them were styrene and its dimer and trimer. In air atmosphere, the concentration of low molecular weight degradation products increases with the temperature while in nitrogen the maximal concentrations of some of them are reached at temp. 500°C.

Key words: polystyrene, thermal and thermooxidative degradation, products identification.

Polystyrene (PS) is one of the most often manufactured and used plastics. According to the forecast, the world production of plastics will increase to 220 mln ton in 2005. Introduction of high-impact polystyrene brought again an increase in demand for this material. Polystyrene materials are used in packaging production (46%), electronic industry (15%), and details for household appliances manufacturing (39%) [1–2]. However, demand increase in plastics including polystyrene leads to cumulation of waste material and brings the necessity of its recycling. Thermal recycling is one of the most recent, efficient methods of waste utilization. Currently about 15% of plastic waste is recycled, but anyway research on the development of this method is still continued [1–8].

THE MECHANISM OF PS THERMAL DEGRADATION

For the development of the thermal recycling, the knowledge about thermal and thermooxidative degradation processes and their mechanisms is very impor-

tant. It was expected that thermal decomposition of PS was the inverse of polymerization and the primary scissions occurred at the weak points of the chain, which were often connected with the presence of the impurities in the polymer [9–10]. The qualitative analyses of the products evolved during PS thermal degradation indicated that in this process a lot of competitive reactions took place. It was suggested that the simple depolymerization was accompanied by free radical reactions [10–18]. The main reactions, which occur during thermal and thermooxidative degradation of PS are:

— Initiation — which leads to macroradicals formation, mainly *via* the random scissions of the chain.

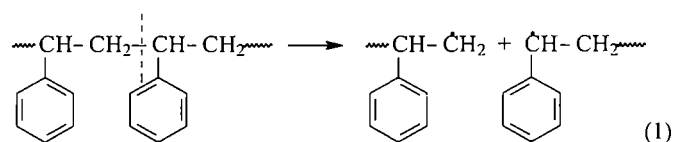

Besides, the chain-end initiation reactions can occasionally take place:

— Depropagation — which leads to the monomer (styrene) formation.

— Intramolecular transfer — migration of hydrogen atoms situated at the tertiary carbon atoms. The radicals

^{*)} Author to whom all correspondence should be send; e-mail: MagdalenaKrause@gmx.de

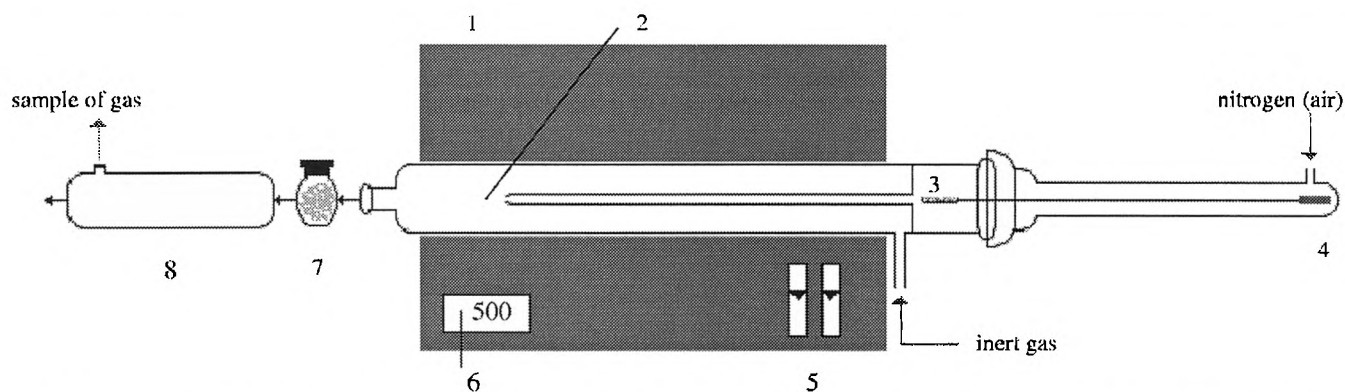

Fig. 1. Scheme of apparatus used for the studies of PS thermal degradation: 1 — flow tubular furnace, 2 — quartz tube, 3 — quartz boat with PS sample, 4 — magnet, 5 — flowmeter, 6 — temperature indicator, 7 — container with glass wool, 8 — gas sampling pipette (for details see the text)

standard DIN 51 006 (1990) [26]. The standard is related to thermogravimetric analyses. The way of T_a and T_b determination from TGA curve was shown in Fig. 2 on the example of T_a degradation beginning temperature in nitrogen atmosphere.

FT-IR spectroscopy

For the infrared spectroscopy analyses, the thermal degradation products were collected in a gas sample pipette with KBr walls. The polystyrene thermal degradation process lasted 30 min every time. The infrared studies were performed using the "SPECTRUM 1000" (Perkin-Elmer) spectrophotometer. The range of the wave numbers during FT-IR analyses was from 400 to 4000 cm^{-1} . The volatile products were taken to the analysis in the second minute after the experiment beginning. The well-marked absorption bands are present in the spectrum of the degradation products at 600°C. At this temperature the polymer degradation took place just the first minutes of the process, so the gaseous products concentrations were high enough to cause the changes in the spectrum. With the temperature decreasing, FT-IR spectra became less sharply outlined.

GC-MS analysis

The analyses of the particular polystyrene thermal degradation products were performed using gas chromatography method with the mass selective detector. Axel Semrau GCQ-MS gas chromatograph was used for the analyses. Compounds were separated on a capillary column "CHROMPACK CP-Sil 5CB" (30 m \times 0.25 mm I.D., film thickness 0.25 mm). Helium was used as a carrier gas at a linear velocity of 40 $\text{cm} \cdot \text{sec}^{-1}$. The column temperature was programmed from 40°C to 60°C with ramp rate 1°C $\cdot \text{min}^{-1}$ and from 60°C to 300°C with ramp rate 20°C $\cdot \text{min}^{-1}$. The ion source temperature was 200°C and the voltage — 70 eV. The mass unit range during measurements was 40–250 m/z . The mass spectra library NIST 98 was used for the identification. The presence of the selected compounds was confirmed by the

comparison of their retention times with those obtained from the analyses of standards.

RESULTS AND DISCUSSION

Thermogravimetry

On the basis of thermogravimetric curves obtained, the range of temperature at which the tested polymer decompose was found.

The selected TGA and DTG curves obtained in nitrogen or air atmosphere are shown in Fig. 2. The data from the thermogravimetric analyses are presented in Table 1. The "temperature range" column presents the range of the temperature at which the mass changes of the polymer during the experiment were observed. T_a and T_b are the temperatures of the beginning and the end of polymer thermal degradation, respectively. T_{max} is the temperature of DTG curve maximum at which a maximal rate of the polymer degradation took place.

Table 1. The effects of atmosphere and heating rate on the results of TG analyses of PS (for symbols see the text)

Atmosphere	Heating rate $^{\circ}\text{C} \cdot \text{min}^{-1}$	Temperature range $^{\circ}\text{C}$	T_a , $^{\circ}\text{C}$	T_{max} , $^{\circ}\text{C}$	T_b , $^{\circ}\text{C}$	Weight loss, %
Air	5	186–527	343	396	418	91.85
	10	240–562	354	414	428	91.74
	20	242–573	364	424	435	91.63
Nitrogen	5	198–470	397	426	446	98.06
	10	229–489	404	441	462	97.51
	20	242–502	423	451	474	97.16

The data collected in Table 1 indicate that an increase in the sample heating rate results in remarkable increasing in the degradation temperature (T_a , T_m , T_b). The kind of the atmosphere also influences the process of PS ther-

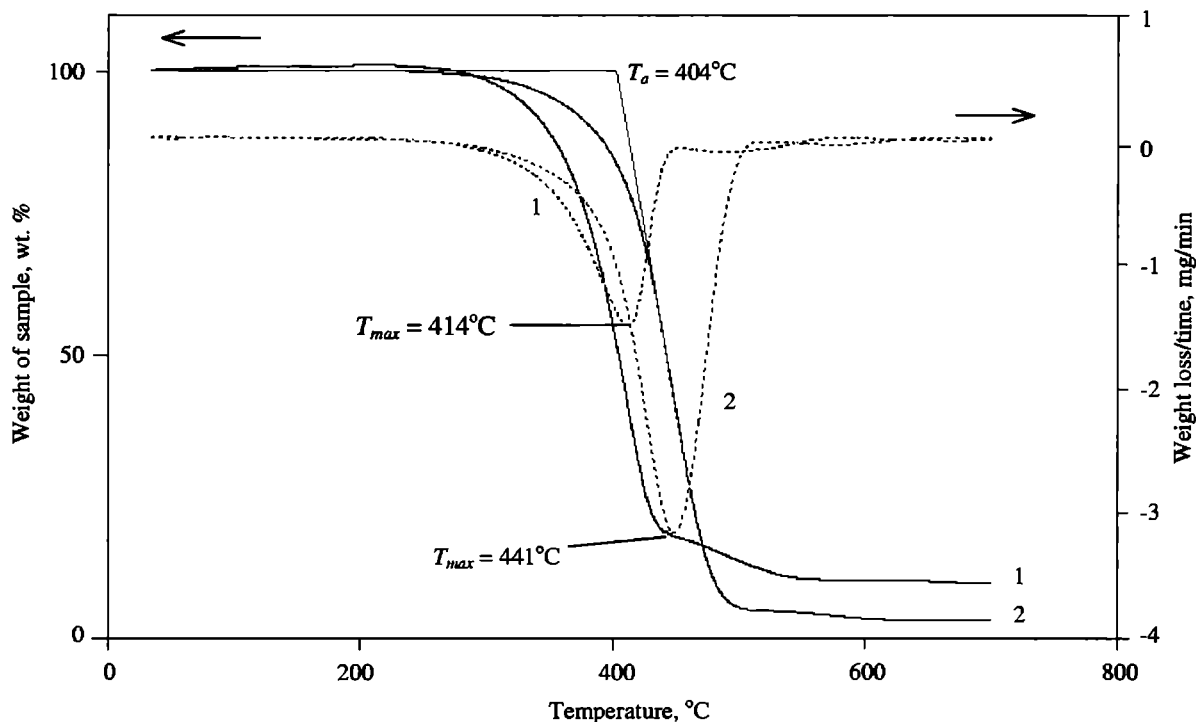

Fig. 2. TGA and DTG curves of polystyrene; atmosphere: 1 — air, 2 — nitrogen (for symbols see the text)

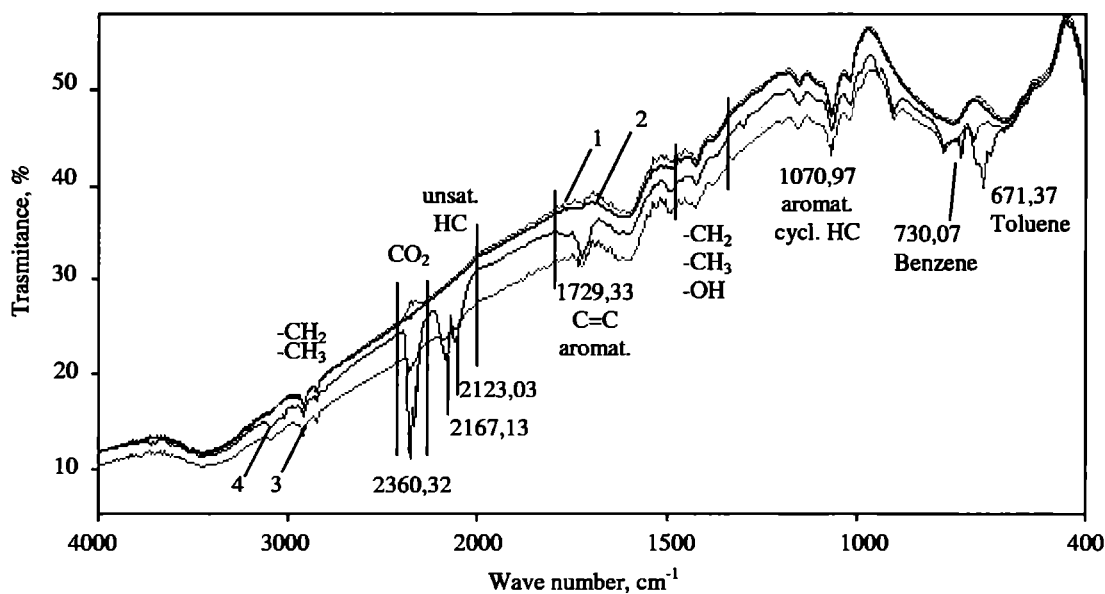

Fig. 3. FT-IR spectra of the volatile PS thermal degradation products in an air; temperature: 1 — 300°C, 2 — 400°C, 3 — 500°C, 4 — 600°C

mal degradation. In the oxidative atmosphere this process took place at tens of degrees lower than in the inert atmosphere.

The shape of the thermogravimetric curves (Fig. 2) indicates the different mechanisms of polystyrene degradation in those atmospheres. In the air atmosphere, a small additional decrease in the polymer mass, at the temperature range of 430–550°C, was observed. This may indicate the reactions of oxygen with the organic compounds from the analyzed sample or the reactions

with PS primary degradation products. The participation of oxygen in PS thermal degradation process was confirmed by an appearance of oxygen-containing compounds among the degradation products.

In the nitrogen atmosphere the analyzed polystyrene sample decomposed in about 98%, and in the air — ca. 92%. The smaller degree of the sample weight loss in the air atmosphere may be caused by the formation of the non-volatile products with the oxygen participation, which decompose slowly at higher temperatures.

FT-IR spectroscopy

Due to the high complexity of PS thermal degradation products mixtures, the FT-IR analyses was useful only for the approximate estimation of the kind of compounds evolved. The exemplary FT-IR spectra of PS thermal degradation products in the air atmosphere are shown in Fig. 3.

The analysis of FT-IR spectra showed that the evolved products consisted mainly of aromatic compounds (peaks at 671, 730, 1070, and 1729 cm^{-1}). Peaks found at 1250–1350, 1490–1780, and 2000–2220 cm^{-1} indicated the presence of alkyl groups, alkanes or alkenes. The evolved products may include also alcohols or phenols (1070 cm^{-1}). The intense sharp peak at 2360 cm^{-1} shows the presence of CO_2 in the analyzed sample.

FT-IR spectra of the polystyrene degradation products in the nitrogen atmosphere are similar to those obtained in the air.

GC-MS analysis

The identified compounds obtained during degradation in various temperatures and atmospheres are collected in Table 2. Among the polystyrene thermal degra-

ation products 64 compounds were identified. The analyses showed, in the whole temperature range, that the main products were: styrene, styrene dimer (*SD*), and styrene trimer (*ST*). The considerable amounts of carbon dioxide, toluene, ethylbenzene, α -methylstyrene, 1,3-diphenylpropane, 1,2-diphenylethylene, 1,4-diphenyl-1,3-butadiene, 2-phenylnaphthalene were also found.

In the air atmosphere, methylstyrene, propylbenzene, indane, propyltoluene, 3-butylbenzene, 1-methylnethylbenzene and 1,2-dihydro-6-methylnaphthalene were not detected among the thermal degradation products. Instead of this, the formation of the oxygen-containing compounds took place. However, these compounds — benzaldehyde, benzofuran, phenol, α -tolylaldehyde, acetophenone, cresol, ethylphenol, 2[3H]-benzofuranone, 3-phenyl-2-propenol, 1-indanone, 3-phenyl-2-propenal, naphthaldehyde, 2-naphthol, dibenzofuran, benzophenone, benzonaphthofuran — were not detected during the thermal degradation in the nitrogen atmosphere.

The domination of styrene between the other products may be seen in the chromatograms (Figs. 4 and 5), especially in the nitrogen atmosphere. As we noted previously the less-volatile compounds trapped on the glass

Table 2. Compounds emitted during the thermal degradation of PS in nitrogen (N) and air (A) atmospheres*¹

No	R_T min	Compound	MW	Main Mass- fragments	Temperature, °C							
					300		400		500		600	
					N	A	N	A	N	A	N	A
1	1.10	Carbon dioxide	44	16, 28, 44	X ^t	X ^t	X ^t	X	X	X	X	X ⁿ
2	1.95	Benzene	78	50, 51, 52, 53	X	-	X	-	X	X	X	X
3	3.21	Toluene	92	63, 65, 91, 91	X	-	X ^m	X	X ^m	X	X ^m	X ^m
4	5.70	Ethylbenzene	106	65, 91, 106, 107	-	-	X	X ^t	X ^m	X	X ^m	X
5	6.84	Styrene	104	51, 78, 103, 104	X ^m	X	X ^m	X	X ^m	X ^m	X ^m	X ⁿ
6	8.58	Cumene	120	77, 78, 104, 105	-	-	X	-	X	-	X	X
7	9.53	X-Methylstyrene	118	65, 91, 115, 117	-	-	X	-	X	-	X	-
8	9.66	Benzaldehyde	106	51, 77, 105, 106	-	X	-	X	-	X	-	X ⁿ
9	10.14	Propylbenzene	120	65, 91, 120	-	-	-	-	X	-	X	-
10	12.03	α -Methylstyrene	118	103, 117, 118	-	-	X	X	X ^m	X	X ^m	X ^m
11	12.53	Benzofuran	118	89, 90, 118, 119	-	-	-	-	-	X ^t	-	X
12	12.54	Indane	118	115, 117, 118	X ^t	-	X	-	X	-	X	-
13	13.01	Phenol	94	39, 65, 66, 94	-	-	-	X ^t	-	X	-	X ⁿ
14	14.22	<i>p</i> -Propyltoluene	134	79, 105, 134	-	-	-	-	X	-	X	-
15	15.40	α -Tolylaldehyde	120	65, 91, 92, 120	-	-	-	X	-	X	-	X ⁿ
16	16.24	Indene	116	63, 89, 115, 116	-	-	-	-	X	X ^t	X	X
17	16.79	3-Butenylbenzene	132	65, 91, 104, 132	-	-	-	-	X	-	X	-
18	17.52	Acetophenone	210	51, 77, 105	-	X ^t	-	X	-	X	-	X
19	18.40	α -Ethylstyrene	132	103, 115, 117	-	-	-	-	X	X ^t	X	X
20	21.20	Cresol	108	77, 79, 107, 108	-	-	-	-	-	-	-	X
21	22.30	Isobutylbenzene	134	43, 91, 92, 134	-	-	-	-	-	-	-	X
22	23.28	1-Methylenbutylbenzene	146	115, 117, 118	-	-	-	-	X	-	X	-
23	23.84	Naphthalene	128	102, 128, 129	-	-	-	-	X	X	X	X
24	24.00	X-Ethylphenol	122	77, 107, 122	-	-	-	-	-	-	-	X
25	24.40	2[3H]-Benzofuranone	134	78, 106, 134	-	-	-	-	-	X ^t	-	X
26	24.73	3-Phenyl-2-propenol	134	77, 92, 102, 103	-	X ^t	-	X	-	X	-	X
27	25.10	1-Indanone	132	51, 78, 104, 132	-	X ^t	-	X	-	X	-	X

28	25.44	X-Methylnaphthalene	142	115, 141, 142	-	-	-	-	X	X	X	X
29	25.50	1,2-Dihydro-6-methylnaphthalene	144	128, 129, 144	-	-	-	-	X	-	X	-
30	25.62	Y-Methylnaphthalene	142	115, 141, 142	-	-	-	-	X	X	X	X
31	26.29	Biphenyl	154	152, 153, 154	X ^t	-	X	-	X	X	X	X
32	26.36	3-Phenyl-2-propenal	132	103, 131, 132	-	-	-	-	-	X	-	X
33	26.45	α -Ethyl-naphthalene	156	115, 141, 156	-	-	-	-	-	-	-	X
34	26.50	X-Methylbiphenyl	168	153, 167, 168	-	-	X	X	X	X	X	X
35	26.72	Y-Methylbiphenyl	168	153, 167, 168	-	-	X	X	X	X	X	X
36	26.93	X,Y-Dimethylnaphthalene	156	115, 141, 156	-	-	-	-	-	-	-	X
37	27.15	Diphenylmethane	168	152, 167, 168	-	-	-	-	-	-	-	X
38	27.19	X-Naphthaldehyde	156	127, 155, 156	-	-	-	-	-	-	-	X
39	27.27	2-Naphthol	144	115, 116, 144	-	-	-	-	-	-	-	X
40	27.33	[E]-Stilbene	180	178, 179, 180	-	-	X	X	X	X	X	X
41	27.36	1,1-Diphenylethylene	180	51, 165, 180	-	-	-	-	-	X	-	X
42	27.38	Dibenzofuran	168	139, 168, 169	-	-	-	-	-	-	-	X ^t
43	27.41	Bibenzyl	182	91, 104, 182	-	-	X	X	X	X	X	X ^m
44	27.63	α -Methylbibenzyl	196	79, 104, 105	-	-	X	X	X	X	X	X
45	27.82	Fluorene	166	165, 166, 167	-	-	-	-	-	X ^t	X	X
46	27.92	X-Methylfluorene	180	165, 180, 181	-	-	-	-	X	X ^t	X	X
47	28.05	Benzophenone	182	51, 77, 105, 182	-	-	-	X	-	X	-	X
48	28.28	1,3-Diphenylpropane	196	91, 93, 105, 196	X ^t	X	X ^m	X	X ^m	X ^m	X ^m	X ^m
49	28.49	9,10-Dihydroanthracene	180	178, 179, 180	-	X	-	X	-	X	X	X
50	28.58	1,2-Diphenylethylene	180	165, 179, 180	-	X	X ^m	X	X ^m	X ^m	X ^m	X ^m
51	28.68	Styrene dimer (SD)	208	91, 130, 208	X ^t	X	X ^m	X	X ^m	X ^m	X ^m	X
52	29.03	Anthracene	178	152, 178, 179	-	-	-	X	X	X	X	X
53	29.42	1-Phenylnaphthalene	204	101, 202, 204	-	-	X	X	X	X	X	X
54	29.48	X-Methylantracene	192	191, 192, 193	-	-	-	X	X	X	X	X
55	29.63	2,5-Diphenyl-1,6-hexadiene	234	115, 130, 143	-	-	X	-	X ^m	X	X	X
56	29.66	X,Y-Dimethylantracene	206	189, 191, 206	-	-	-	X	X	X	X	X
57	29.94	1,4-Diphenyl-1,3-butadiene	206	91, 128, 206	-	X	X ^t	X	X	X ^m	X ^m	X ^m
58	30.04	2-Phenylnaphthalene	204	202, 204, 205	-	X	X ^t	X	X ^m	X ^m	X ^m	X ^m
59	30.52	Fluoranthene	202	200, 202, 203	-	-	-	-	-	X	-	X
60	30.67	2-Benzyl-naphthalene	218	202, 217, 218	-	-	-	-	X	X	X	X
61	30.86	Benzonaphthofuran	218	189, 218, 219	-	X	-	X	-	X	-	X
62	30.89	<i>m</i> -Terphenyl	230	218, 230, 231	-	-	-	X	-	X	X ^m	X ^m
63	31.07	<i>p</i> -Terphenyl	230	218, 230, 231	-	-	-	-	-	-	X	X
64	32.22	Styrene Trimer (ST)	312	91, 208, 312	X	X	X ^m	X ^m	X ^m	X ^m	X	X

^{a)} X^m — main product, X — one of the products of equal rank, X^t — traces.

R_T — retention time, MW — molecular weight.

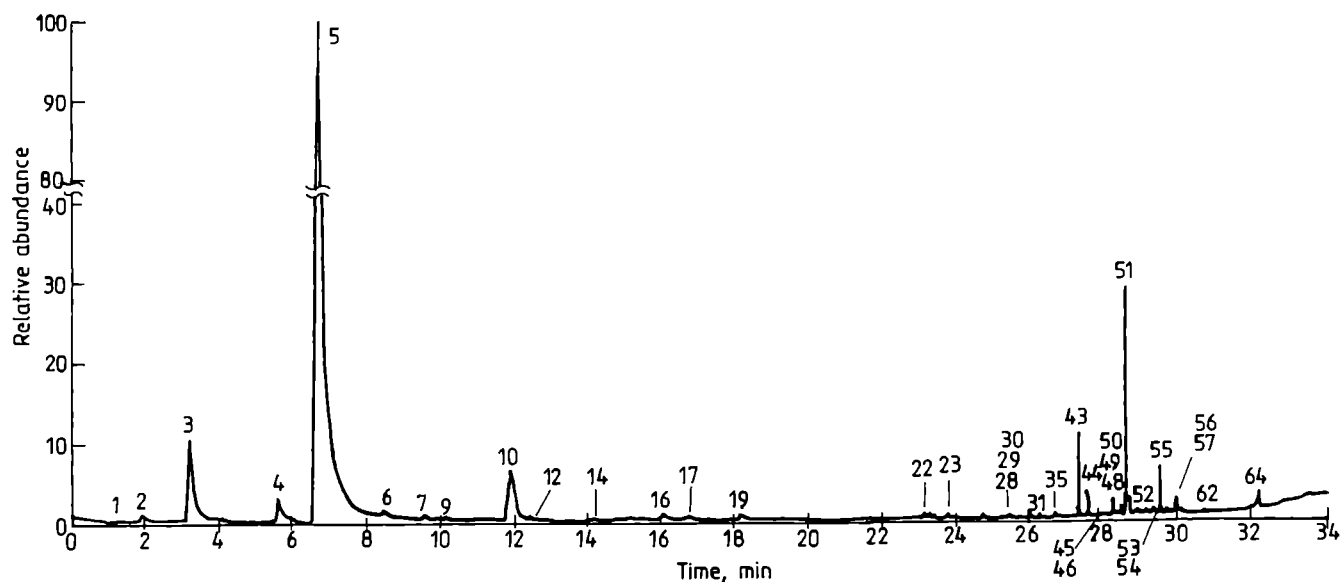

Fig. 4. Total ion chromatogram of the compounds evolved from PS during second minute of thermal degradation in nitrogen at 600°C. The peaks numbers according to Table 2

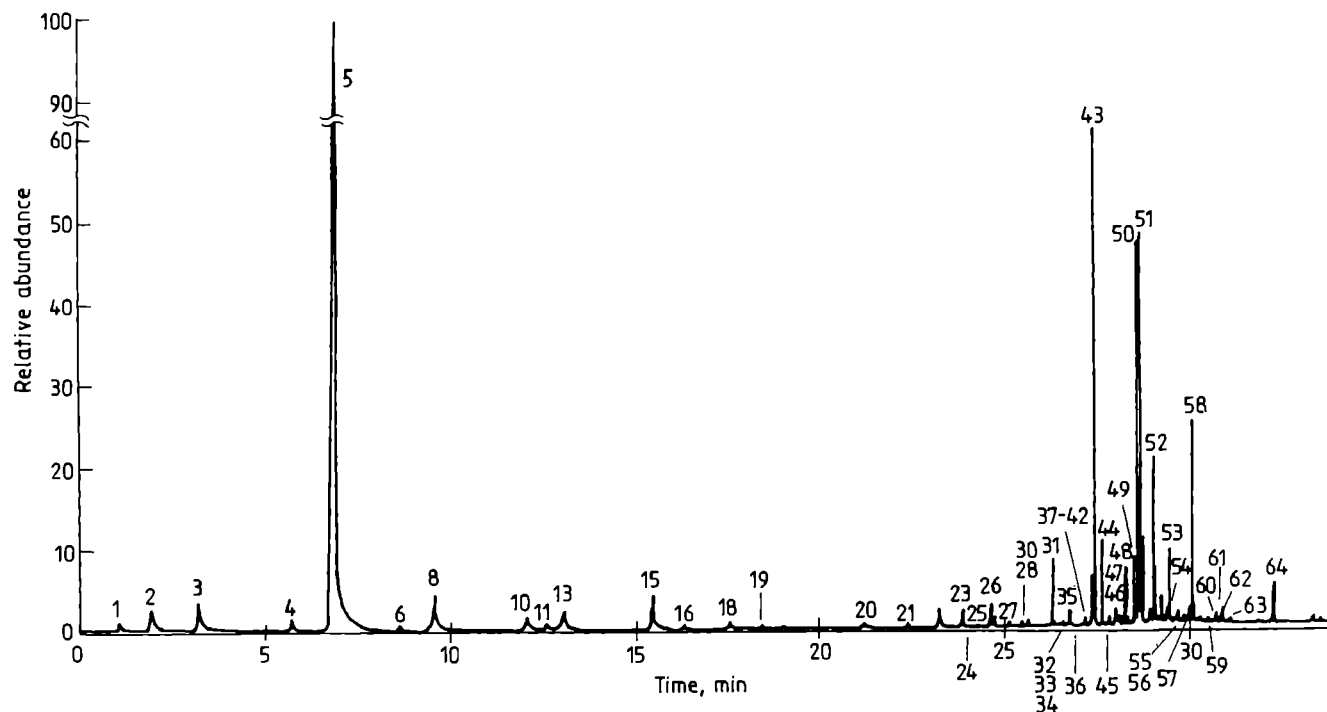

Fig. 5. Total ion chromatogram of the compounds evolved from PS during second minute of thermal degradation in air at 600°C. The peaks numbers according to Table 2

wool were analyzed separately. Their small amounts were permeated into the gas pipette and may be seen on the chromatograms presented. Only one of the oxygen-containing compounds — carbon dioxide — was evolved during the thermal degradation in both atmospheres. The traces of oxygen during the thermal degradation process in the inert atmosphere were observed also by other investigators [12]. The source of oxygen could be plastics additives.

The great domination of styrene between the polystyrene thermal degradation products may confirm the idea that the degradation process is partially proceeding by the depolymerization reaction. However, at higher temperature the polymer fragmentation increases and a wide variety of compounds is observed. The formation of these compounds is the result of the process of secondary degradation of the primary products. It means that the thermal degradation process of polystyrene is complicated by various competitive reactions, mainly reactions with the intramolecular transfer mechanism.

The dependence of the selected volatile compounds amounts evolved from PS on the degradation temperature is shown in Figs. 6 and 7. For the legibility of figures the data concerning the main product — styrene — were not inserted. The amounts of evolved styrene were about 100-times bigger than of other volatile products. Nevertheless, the character of the evolved styrene amounts dependence on the degradation temperature is similar to those presented in Figs. 6 and 7.

At temperature range investigated, the amounts of the compounds evolved in air atmosphere increased

continuously with the temperature rise. Nevertheless, during degradation in nitrogen, α -methylstyrene, toluene and ethylbenzene reached a maximum at temperature 500°C. The compounds of higher molecules (e.g. trimer) undergo further degradation at higher temperature. The maximal yields of the trimer were observed at 400–500°C. The dependences of the evolved volatile compounds amounts on PS degradation time were studied for each temperature, too. The gas samples were analyzed after 2, 5 and 10 minutes from the degradation beginning. At lower temperature (300°C and 400°C) the small amounts of the volatile products were emitted and

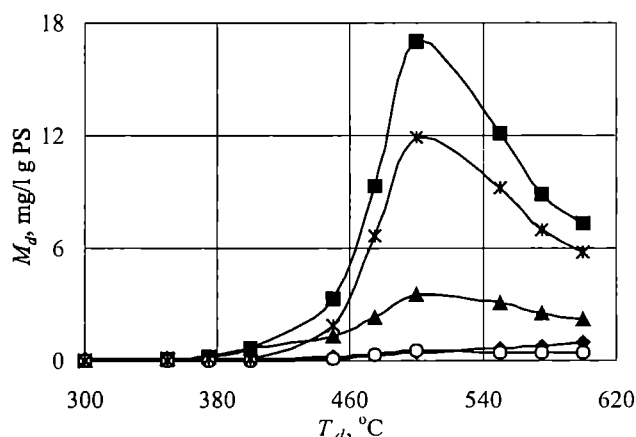

Fig. 6. Dependence of mass of PS degradation products (M_d) in nitrogen on degradation temperature (T_d) at second minute of the degradation: 1 — benzene, 2 — toluene, 3 — ethylbenzene, 4 — cumene, 5 — α -methylstyrene

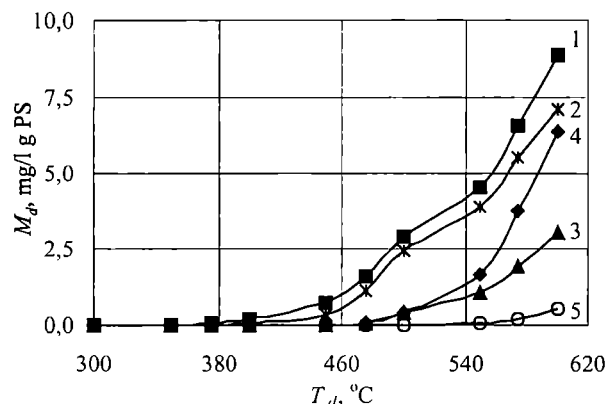

Fig. 7. Dependence of mass of PS degradation products (M_d) in air on degradation temperature (T_d) at second minute of the degradation; for curves symbols see Fig. 6

their maximal concentrations were found in 5th minute of degradation. At 500°C and 600°C polystyrene decomposed very fast and the maximal yields of the evolved compounds were observed in the second minute after the experiment beginning.

The identified products formed a complex mixture of aromatic compounds — from benzene to oligomers and polycyclic aromatic hydrocarbons. The inconsiderable part of polystyrene thermal degradation products was not identified, and some isomers were not distinguish. To solve this problems, the further analyses using mass spectrometry with chemical ionization or tandem MS/MS spectrometry could perform.

CONCLUSIONS

The thermogravimetric studies showed that 92—98% of polystyrene decomposed at the temperature range of 190—570°C depending on the kind of the atmosphere. In the inert atmosphere the thermogravimetric curve has a single-stage run, whereas in the oxidative atmosphere the small additional weight loss is observed at higher temperature.

FT-IR analyses showed the presence of aromatic compounds, alcohols, phenols, and compounds with alkane or alkene substituents among the thermal degradation products. Using gas chromatography method with the mass selective detector, 64 compounds evolved during PS thermal degradation were identified. The kind of the atmosphere influences the composition of the evolved compounds, but the main products are always: styrene, dimer and trimer of PS. It was found, that in both nitrogen and air atmospheres, the concentrations of low-molecular substances increase with the temperature rise, while the amounts of high-molecular compounds decrease above 500°C, because they undergo the secondary fragmentation.

All of the identified substances (except carbon dioxide) are the aromatic compounds and may create a hazard of toxicity.

REFERENCES

1. Figa R.: *Przemysł chemiczny w świecie* 2001, 3, 9 (in Polish).
2. Anonim: *Przetwórstwo tworzyw* 2001, 6, 151 (in Polish).
3. Rymarz G., Klecan T.: *Przetwórstwo tworzyw* 2001, 2, 35 (in Polish).
4. Haerdle G., Marek K., Bilitewski B., Kijewski K.: "Recycling von Kunststoffabfaellen", Erich Schmidt, Berlin 1991, p. 79.
5. Sattler K., Enberger J.: "Behandlung fester Abfaelle", Vogel, Wuerzburg 1992, p. 105.
6. Noethe M.: "Abfall. Behandlung, Management, Rechtsgrundlagen", Wiley-VCH, Weinheim 1999, p. 149.
7. Bilitewski B., Haerdle G., Marek K.: "Abfallwirtschaft. Eine Einfuehrung", Springer, Berlin 1994, p. 245.
8. Brandrup J.: "Die Wiederverwertung von Kunststoffen", Hanser, Muenchen 1995, p. 393.
9. Vasile C.: "Handbook of Polyolefins", Marcel Dekker, New York 2000, p. 413.
10. Yang M., Shibasaki Y.: *J. Polym. Sci., Part A: Polym. Chem.* 1998, 36, 2315.
11. Grassie N., Scott G.: "Polymer Degradation and Stabilization", Cambridge Univ. Press, Cambridge 1985, p. 17.
12. Shapi M. M.: *J. Anal. Appl. Pyrolysis* 1990, 18, 143.
13. Swistek M., Ben Ismail N., Nicole D.: *Polym. Recycl.* 1997/98, 1, 67.
14. Swistek M., Nguyen G., Nicole D.: *J. Appl. Polym. Sci.* 1996, 60, 1637.
15. Matti E., Saharinen E.: *J. Appl. Polym. Sci.* 1991, 42, 2819.
16. Bar-Long D.: *Polym. Degrad. Stab.* 1997, 57, 261.
17. Sawaguchi T.: *J. Polym. Sci., Part A: Polym. Chem.* 1998, 36, 209.
18. Guaita M.: *Br. Polym. J.* 1986, 18, 226.
19. McNeill J. C., Zulficar M.: *Polym. Degrad. Stab.* 1990, 28, 131.
20. Hawkins W. L.: "Polymer Degradation and Stabilization", Springer, Berlin 1984, p. 3.
21. Bamford C. D., Tipper C. F. H.: "Degradation of Polymers", Elsevier, Amsterdam 1975, p. 44.
22. Madorsky S. L.: "Thermal Degradation of Organic Polymers", Interscience Publ., New York 1964, p. 26.
23. Grassie N.: "Chemistry of High Polymer Degradation Processes", Butterworth, London 1956, p. 50.
24. Wiezorek B.: "Umweltanwendungen von Gaschromatographie/Massenspektrometrie", Univ. Diss., Bremen 1993, p. 73.
25. Zitting A.: "Thermal Degradation Products of PE, PP, PS, PVC", Arbetsmiljoinstitutet, Solna 1998, p. 18.
26. Ehrenstein G. W., Riedel G., Trawiel P.: "Praxis der Thermischen Analyse von Kunststoffen", Hanser, Muenchen 1998, p. 111.

Received 14 X 2002.