

Effectiveness of polyethylene extrusion in a single-screw grooved feed extruder

Emil Sasimowski¹⁾, Janusz W. Sikora^{1),*}, Bogusław Królikowski²⁾

DOI: dx.doi.org/10.14314/polimery.2014.505

Abstract: The paper presents a description of a modern direct screw drive carried out by a torque motor of a torque 300 Nm, maximum rotational speed 500 rpm and power 15.7 kW. The operation of the torque, its advantages and disadvantages were described. In the extruder plasticizing system in the feed opening zone and part of the feed zone, an exchangeable smooth sleeve and a grooved sleeve with 6 or 8 longitudinal grooves were used. For research, low density polyethylene of the commercial name Malen E and symbol FG NX 23-D006 was used. In the extruder barrel, a special screw was mounted 25 mm in diameter and $L/D = 24$, with elements of intensive shearing and mixing, constructionally adapted to the grooved section. The research was conducted in the wide range of rotational screw speeds from 1.67 to 8.33 rps.

Keywords: single screw extruder, grooved feed extruder, grooved sleeve, direct screw drive, low density polyethylene.

Efektywność wytłaczania polietylenu przy użyciu wytłaczarki jednoślimakowej ze strefą rowkowaną

Streszczenie: Badano proces wytłaczania polietylenu małej gęstości z zastosowaniem wytłaczarki, w której ślimak był napędzany bezpośrednio za pomocą silnika momentowego o momencie obrotowym 300 Nm, maksymalnej szybkości obrotowej 500 obr/min i mocy 15,7 kW. W układzie uplastyczniającym wytłaczarki, w strefie zasypu i części strefy zasilania zastosowano wymienną tuleję gładką oraz tuleję rowkowaną z 6 oraz 8 rowkami wzdłużnymi. W cylindrze wytłaczarki zamontowano ślimak specjalny o średnicy 25 mm i stosunku $L/D = 24$, z elementami intensywnego mieszania i ścinania, przystosowany konstrukcyjnie do strefy rowkowanej. Badania prowadzono w szerokim zakresie szybkości obrotowej ślimaka, od 1,67 do 8,33 s⁻¹. Dla różnych rozwiązań konstrukcyjnych strefy rowkowanej wyznaczono zależności: masowego natężenia przepływu tworzywa, mocy pobieranej przez wytłaczarkę oraz jednostkowego zużycia energii, od szybkości obrotowej ślimaka. Stwierdzono, że zastosowanie tulei z 6 rowkami skutkuje zwiększeniem masowego natężenia przepływu tworzywa (odpowiednio, 17,5 %; 8,6 %; 5,5 %; 3,2 % oraz 5,7 %) w porównaniu z wartością uzyskiwaną w przypadku wykorzystania tulei z powierzchnią wewnętrzną jednolitą geometrycznie. Zastosowanie tulei z ośmioma rowkami wpływa na dalsze zwiększenie natężenia przepływu, jednak tylko w ograniczonym zakresie szybkości obrotów ślimaka. Obliczone wartości jednostkowego zużycia energii są bardzo obiecujące. Wyniki wskazują, iż wykorzystanie we współczesnych wytłaczarkach silnika o stałym, dużym momencie obrotowym, niezależnym od szybkości obrotowej i przenoszącym napęd bez przekładni redukcyjnej, jest uzasadnione ekonomicznie.

Słowa kluczowe: wytłaczarka jednoślimakowa, wytłaczarka ze strefą rowkowaną, tuleja rowkowana, napęd bezpośredni ślimaka, polietylen małej gęstości.

The increase in the flow rate and pressure of the polymer in the plasticizing system, as well as the increase of temperature can occur due to the increase of the polymer friction. An effective method to increase the friction on the

barrel surface is making appropriate grooves [1] on a section of the barrel length which results in the increase and stabilization of the polymer flow rate [2]. Usually, the increase in the flow rate is from 20 to 100 % and sometimes even more [3–5]. The grooves, whose depth is the biggest in the feed opening section and usually decreases gradually in the feed section, can be longitudinal or helical and are characterized by a small helix angle of a flight [6–8]. The grooved feed section requires intensive cooling which unfortunately results in the slight worsening of power engineering indicators of the extrusion process [9–11].

¹⁾ Lublin University of Technology, Department of Polymer Processing, Nadbystrzycka 36, 20-618 Lublin, Poland.

²⁾ Institute for Engineering of Polymer Materials and Dies, M. Skłodowskiej-Curie 55, 87-100 Toruń, Poland.

^{*} Author for correspondence; e-mail: janusz.sikora@pollub.pl

In the Department of Polymer Processing of the Lublin University of Technology a research has been conducted for quite a long time in order to improve single screw extruder plasticizing systems. It can be done through the changes in the barrel design consisting in the introduction of an active grooved section with longitudinal or helical grooves, rotational barrel segment and modern direct screw drives [4, 12–23]. One of the accepted improvement trends in the development of plasticizing systems is the advancement of the grooved barrel section. The presented research, which is a continuation of earlier studies, constitutes a part of a bigger investigation carried out within the framework of the research project financed by the Polish Ministry of Science and Higher Education. The aim of the research is to define the influence of constructional changes in the feed opening and feed zone and of using a direct, without a gear, screw drive, on selected characteristics of the extrusion process. The investigation consisted in the measurement, during the extrusion process of low density polyethylene, of the directly defined parameters and on that basis, the calculation of values characterizing this process, such as polymer output, power taken by the extruder and total energy consumption per unit mass. The usage of the torque rotor enabled the measurements in the wide range of the rotational screw speeds from 1.67 to 8.33 rps.

Using a modern direct drive of higher efficiency, compared to the traditional solution with a gear, brings economical benefits for the extrusion process. Transferring the drive directly from the rotor shaft to the screw shaft makes it necessary to use the cutting edge electronically controlled torque rotor. Torque rotors are AC synchronous rotors with permanent magnets. They are characterized with high efficiency (up to 95 %), rigid mechanical characteristics, smooth, silent and maintenance-free operation. Rotors of this type, however, require inner cooling with water, which makes it necessary to use a water thermostat.

EXPERIMENTAL PART

Materials

For research, there was used low density polyethylene of the commercial name Malen E and symbol FG NX 23-D006, produced in the form of pellets by Basell Orlen Polyolefins company [24]. Polymer pellets were in the shape of elliptic rolls with circular edges and average dimensions: length of a major axis 4.4 mm, length of a minor axis 3.8 mm and height 3.0 mm.

Basic properties of this polymer, according to the producer, are the following: density 0.919–0.923 g/cm³, mass flow rate $MFR_{(190\text{ }^{\circ}\text{C}, 2,16\text{ kg})}$ from 0.6–0.9 g/10 min, breaking stress 12 MPa, Vicat softening point 90 °C. The polymer does not contain antioxidants or other modifying additives.

Research station

The investigation of the grooved feed extruder with a direct screw drive was conducted at the special research station equipped with an extruder with an original plasticizing system, presented in Fig. 1. The design of the extruder plasticizing system enables to change the barrel

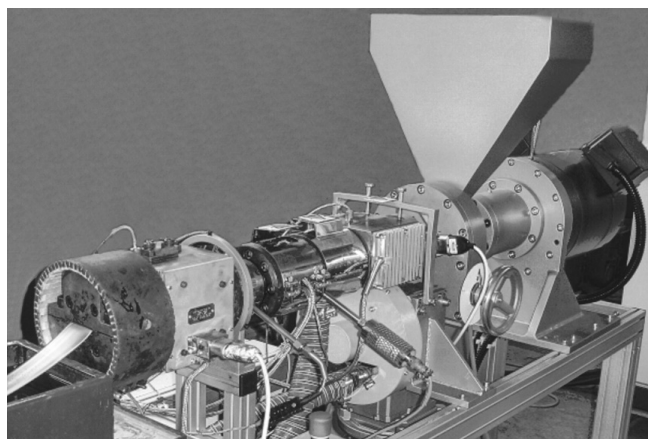

Fig. 1. Plasticizing system, extruder head and torque motor as parts of the research station

sleeve in the feed opening zone and part of the feed zone. During the measurements there were used sleeves of geometrically uniform inner surface — smooth or grooved with 6 or 8 longitudinal grooves (Fig. 2). Sleeve grooves had a trapezoid cross-section shape, width at the screw 5 mm and width at the bottom 4.5 mm. The grooves had the biggest depth in the feed opening zone = 1.5 mm and disappeared at the length of the feed zone (200 mm). The station was also equipped with slit extruder head for extruding flat bars, sensors of processed polymer pressure and temperature, a measurement system for data collecting and processing integrated with a computer, control panel, water thermostat and other component elements. An example of a control screen of the computer measurement system is presented in Fig. 3. In the extruder there

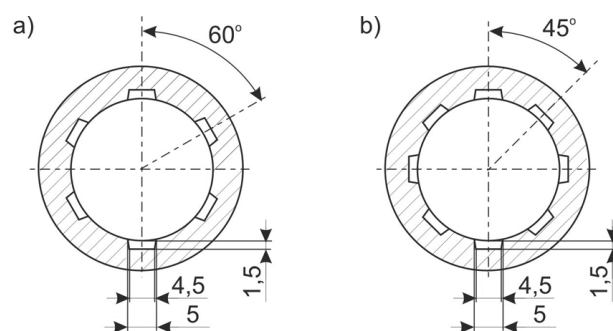

Fig. 2. Cross-section of the sleeves with a) 6 or b) 8 longitudinal trapezoid shape grooves

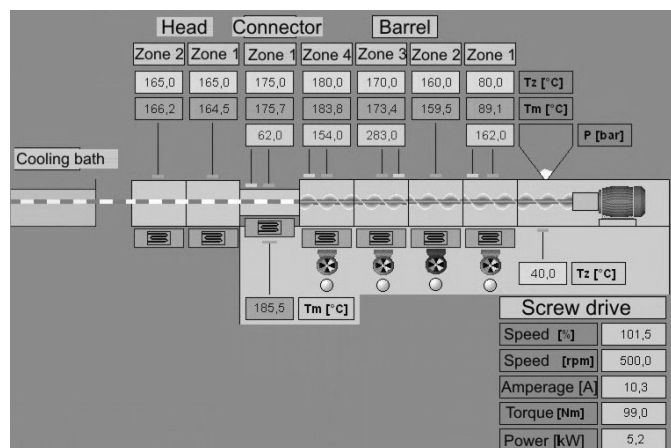

Fig. 3. Example of a control screen of the computer measurement system

was used a special screw 25 mm in diameter and $L/D = 24$ with elements of intensive shearing and mixing, shown in Fig. 4, designed for processing of low density polyethylene and constructionally adapted to the grooved section. The screw was driven directly by a modern Siemens 1FW3154 torque rotor of the power 15.7 kW and

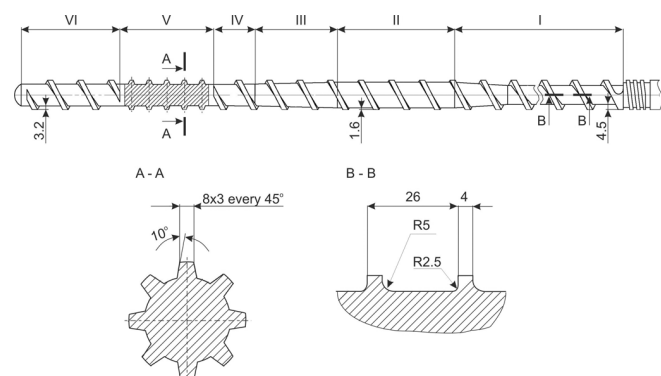

Fig. 4. Special screw 25 mm in diameter and $L/D = 24$ with elements of intensive shearing and mixing, designed for processing of low density polyethylene; screw zones: I – feeding zone, II – compression zone, III – plasticizing zone, IV – decompression zone, V – mixing zone, VI – metering zone

torque 300 Nm with Siemens SINAMICS S120 control system, which enables a continuous adjustment of the rotational speed in the range 0–8.33 rps.

Research program and methodology

The set temperature in particular zones of the extruder plasticizing system, selected on the basis of literature [25–28] and own experiments, was in the particular zones $T_I = 80\text{ °C}$, $T_{II} = 160\text{ °C}$, $T_{III} = 170\text{ °C}$, $T_{IV} = 180\text{ °C}$, $T_V = 175\text{ °C}$, and the temperature of extruder head was $T_{VI} = 165\text{ °C}$ and $T_{VII} = 165\text{ °C}$. In the feed opening zone cooled

by water thermostat the set temperature was $T_0 = 40\text{ °C}$. The measurements were conducted at the screw speed $n_s = 1.67, 3.33, 5.00, 6.67$ and 8.33 rps.

After each change of the screw speed the process was stabilized before conducting measurements, which in most cases was achieved in a satisfactory extent after about 15 minutes.

It was assumed that the extrusion process is characterized by the following directly measured parameters: mass of the extrudate measured length, temperature of the barrel wall in the defined places of the plasticizing system and extruder head, temperature of the processed polymer in the flow channel before the extruder head and polymer pressure in the defined places of the plasticizing system. The following parameters were determined indirectly: polymer output, power taken by the extruder and energy consumption per unit mass.

Measurements of mass flow rate $MFR_{(190\text{ °C}, 2.16\text{ kg})}$ g/10 min, in the samples of processed polymer and received extrudate were conducted in accordance with PN-EN ISO 1133:2006. The samples were taken randomly out of the whole processed polymer batch and received extrudate at the lowest and highest screw speeds in the study.

RESULTS AND DISCUSSION

Figure 5 presents the pressure distribution of the processed polymer along the plasticizing system in the studied range of screw speed in three constructional solutions of the grooved section used in the research.

It was found out that the application of the sleeves both with 6 and 8 grooves in the grooved barrel section causes a considerable increase in the pressure of the processed polymer measured at the end of the grooved section in relation to the pressure in the smooth geometrical uniform sleeve.

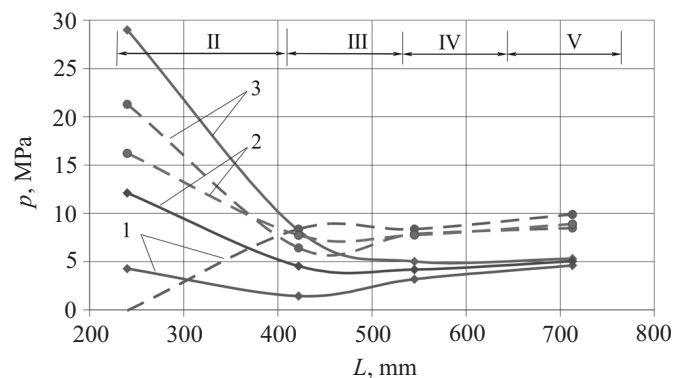

Fig. 5. Dependence of polymer pressure p on the length L of the plasticizing system in different constructional solutions of the grooved section: 1 – geometrically uniform smooth sleeve, 2 – 6-grooved sleeve, 3 – 8-grooved sleeve (screw speed: $n_s = 1.67$ rps continuous line, $n_s = 8.33$ rps – dashed line), II, III, IV and V – heating zones of the plasticizing system

At the lowest screw speed 1.67 rps after using the 6-grooved sleeve the polymer pressure increased 2.8 times (from 4.3 to 7.8 MPa), while after using the 8-grooved sleeve it increased 6.8 times (to 29.0 MPa). After increasing the screw speed to the highest from the studied ones 8.33 rps the pressure at the end of the grooved section with 6 grooves equaled to 16.2 MPa and was higher than the one at the lowest screw speed. In the case of the remaining sleeves, smooth geometrically uniform and 8-grooved sleeve, the polymer pressure at their ends decreased to 0.01 MPa and 21.3 MPa, respectively. Changes in the pressure of the processed polymer in the next, IIIrd zone of the plasticizing system were of a similar character except for the smooth geometrically uniform sleeve whose pressure had the highest value of 8.4 MPa. Differences between the polymer pressure in the next zones of the plasticizing system (IVth and Vth), when using the studied sleeves, were smaller and smaller. The polymer pressure at the highest of the studied screw speeds was clearly higher than the one at the lowest screw speed.

The selected research results of the parameters defined indirectly are presented graphically in Figs 6–9.

Figure 6 shows the dependence of polymer output in the function of the rotational screw speed in different constructional solutions of the grooved section used in the research.

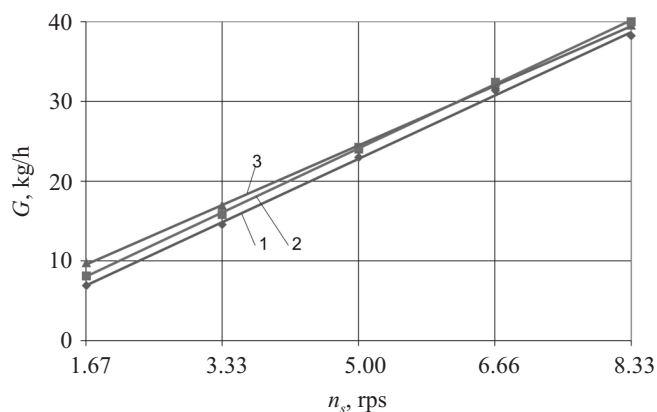

Fig. 6. Polymer output \dot{G} in the function of rotational screw speed n_s in different constructional solutions of the grooved section: 1 – geometrically uniform smooth sleeve, 2 – 6-grooved sleeve, 3 – 8-grooved sleeve

Based on the received results it was stated that using the sleeve either with 6 or 8 grooves in the grooved barrel section caused the increase of polymer output in comparison with the one received for a smooth geometrically uniform sleeve. The increase of polymer output for the 6-grooved sleeve in relation to subsequent screw speeds equaled respectively to 17.5, 8.6, 5.5, 3.2 and 5.7 %. Using the 8-grooved sleeve resulted in the further increase of polymer output in comparison with the one received for the 6-grooved sleeve. However, the increase occurred in

the limited to 3.33 rps range of screw speeds. The increase of screw speed equaled to 20.4 and 7.4 % in relation to the respective screw speeds 1.67 and 3.33 rps. At the screw speeds in the range between 5.00 and 8.33 rps the received results corresponded to the ones received for the 6-grooved sleeve.

The dependence of the power taken by the extruder on the screw speed in different constructional solutions of the grooved section is shown in Fig. 7. The increase in the screw speed resulted in the increase in the power taken by the extruder. When a smooth geometrically uni-

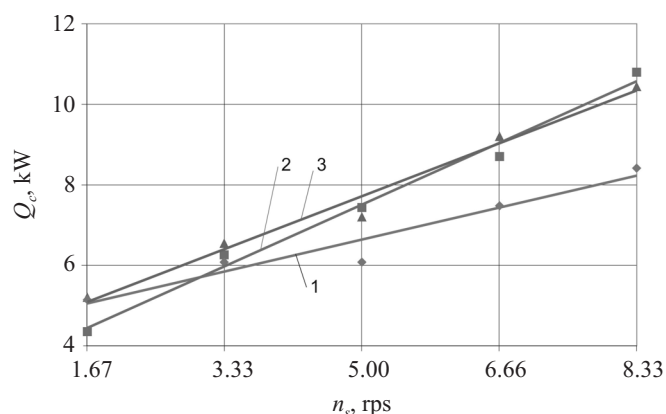

Fig. 7. Power Q_c taken by the extruder in the function of rotational screw speed n_s in different constructional solutions of the grooved section: 1 – smooth geometrically uniform sleeve, 2 – 6-grooved sleeve, 3 – 8-grooved sleeve

form sleeve was used, this increase was the least intensive. When the screw speed was five times bigger, between 1.67 and 8.33 rps the power taken by the extruder increased by 64 % (from 5.1 to 8.4 kW). Using both grooved sleeves resulted in the more intense increase of the power taken by the extruder together with the increase of the screw speed. The power taken by the extruder for both grooved sleeves had similar values, e.g. at the highest screw speed equaled to 10.8 kW – for the 6-grooved sleeve and 10.4 kW – for the 8-grooved sleeve.

The dependence of total energy consumption per unit mass on the screw speed in different constructional solutions of the grooved section is presented in Fig. 8. At the lowest studied screw speed and smooth sleeve, the total energy consumption per unit mass equaled to 2.7 kJ/g. At the same screw speed, the usage of either the 6-grooved or 8 grooved sleeve resulted in the decrease of energy consumption per unit mass by 30 % to 1.9 kJ/g.

The increase in the screw speed caused the further decrease of energy consumption per unit mass as a result of the outweighing increase of polymer output in comparison with the increase of the conducted energy flux. When the screw speed increased five times from 1.67 to 8.33 rps the total energy consumption per unit mass decreased by 70 % (to 0.8 kJ/g) when the smooth geometri-

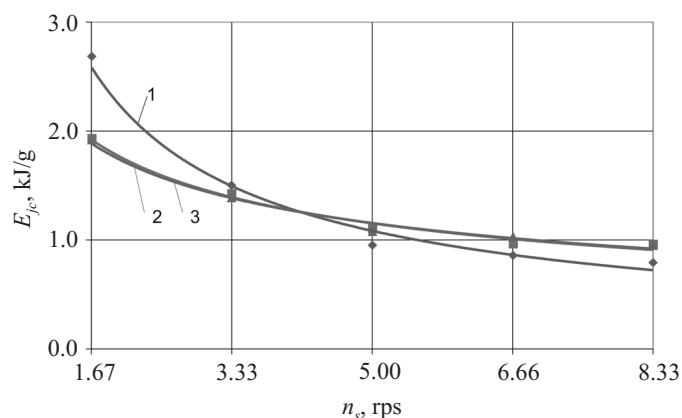

Fig. 8. Total energy consumption per unit mass E_{jc} in the function of the rotational screw speed n_s in different constructional solutions of the grooved section: 1 – smooth geometrically uniform sleeve, 2 – 6-grooved sleeve, 3 – 8-grooved sleeve

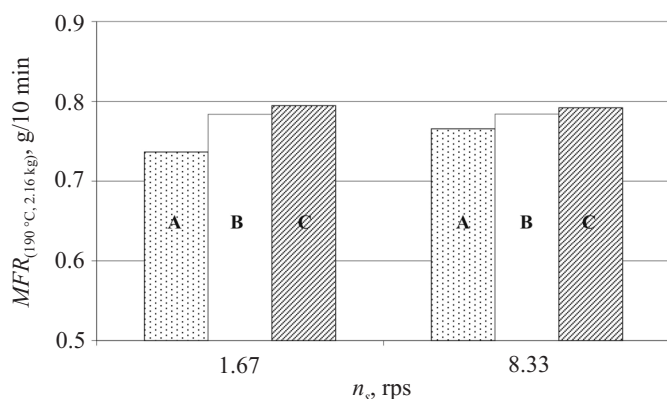

Fig. 9. Dependence of extrudate mass flow rate MFR at different screw rotation speeds $n_s = 1.67; 8.33$ rps; A – smooth geometrical uniform sleeve, B – 6-grooved sleeve, C – 8-grooved sleeve

cally uniform sleeve was used, while for both grooved sleeves it decreased by 49 % (to 0.96 kJ/g).

Figure 9 presents the results of the measurements of mass flow rate $MFR_{(190^\circ\text{C}, 2.16\text{ kg})}$ of the samples taken from the received extrudate in three studied constructional solutions of the grooved section at the lowest and highest of the studied screw speeds. They showed very little variety of received average values.

The arithmetic mean calculated from all studied samples equaled to 0.78 g/10 min. Because the mean from measurements of 10 samples taken randomly from the whole batch of the processed polymer equaled to $MFR_{(190^\circ\text{C}, 2.16\text{ kg})} = 0.78 \pm 0.002$ g/10 min, it can be claimed that the processed polymer did not undergo disadvantageous changes.

CONCLUSIONS

Based on the received results it was stated that using the sleeve either with 6 or 8 grooves in the grooved barrel section resulted in the increase of polymer output in com-

parison with the one received when using smooth geometrically uniform sleeve. Using the 8-grooved sleeve in the grooved barrel section causes the further increase of polymer output in comparison with the one received when using the 6-grooved sleeve but only in the limited range of screw speeds.

The energy consumption per unit mass when using the sleeve with either 6 or 8 grooves is clearly lower than the one for the smooth geometrically uniform sleeve in the screw speed range from 1.67 to 3.33 rps. At higher screw speeds it has similar values.

The studied constructional solutions of the grooved section have no significant influence on the value of the mass flow rate of the received extrudate.

The received results show that using in contemporary extruders a rotor with a constant high torque, independent from the rotational speed and transferring the drive without the gear is economically justified.

REFERENCES

- [1] Darnell W.H., Mol E.A.J.: *Soc. Plast. Eng. J.* **1956**, 1, 20.
- [2] Boes D.: *Kunststoffe* **1970**, 5, 294.
- [3] Knights M.: *Plast. Technol.* **1996**, 10, 46.
- [4] Sikora J.W.: *Polimery* **1997**, 42, 565.
- [5] Yun K.S., Spalding A.: „An experimental investigation of solids conveying in smooth and grooved barrel single-screw plasticating extruders”, The Polymer Processing Society, 14th Annual Meeting, Yokohama, Japan 1998.
- [6] Maddock B.H.: *SPE Journal* **1967**, 7, 23.
- [7] Menges G., Hegele R.: *Kunststoffberater* **1970**, 11, 1071.
- [8] Stasiak J.: „Układy uplastyczniające wytłaczarek jednoślismakowych”, OBR Metalchem, Toruń 1994.
- [9] Boes D., Kramer A., Lohrbacher V., Schneiders A.: *Kunststoffe* **1990**, 6, 659.
- [10] Krueger L.W.: „Grooved feed extrusion”, 39th ANTEC, Boston, USA 1981.
- [11] Stasiak J.: „Wytłaczanie tworzyw polimerowych. Zagadnienia wybrane”, Publisher of University of Technology and Life Science, Bydgoszcz 2008.
- [12] Rauwendaal Ch., Sikora J.W.: *Int. Polym. Proc.* **2000**, 15, 133.
- [13] Samujło B., Sikora J.W.: *Przetwórstwo Tworzyw* **2012**, 5 (149), 511.
- [14] Sasimowski E.: *Polimery* **2008**, 53, 47.
- [15] Sikora J.W., Sasimowski E.: *Kunststoffe International* **2006**, 7, 104.
- [16] Sikora J.W., Sasimowski E.: *Kunststoffe International* **2006**, 9, 89.
- [17] Sikora J.W.: *Polimery* **2006**, 51, 285.
- [18] *Polish pat.* 199 018 (2008).
- [19] Sikora J.W.: „Selected problems of polymer extrusion”, Lublin University of Technology, WNGB, Lublin 2008.
- [20] *Polish pat.* 199 019 (2008).
- [21] Sikora J.W.: „Chapter 5 Screw extrusion” in „Advances in Polymer Processing” (Ed. Sabu T., Yang W.), Woodhead Publishing Limited, Oxford – Cambridge – New Delhi 2009, pp. 106–142.

- [22] Sikora J.W, Samujło B.: „The Effectiveness of The Single Screw Extrusion of Selected Thermoplastic Polymers” in „New materials and it technologies in production engineering” (Ed. Świć A., Lipski J.), Lublin Scientific Society, Lublin 2011, pp. 7–17.
- [23] *Polish pat. appl.* 383 596 (2008).
- [24] <http://www.basellorlen.pl/inside.php?pg=c1f00a592ecfd2edb8dd3ae3230588ac> (accessed May 2013).
- [25] Rauwendaal Ch.: „Polymer Extrusion”, Carl Hanser Verlag, Munich 2001.
- [26] Sikora R.: „Przetwórstwo tworzyw wielkocząsteczkowych”, Educational Publishing, Warsaw 1993.
- [27] Tadmor Z., Gogos C.G.: „Principles of polymer processing”, J. Wiley and Sons Publishers, USA—Canada 2006.
- [28] White J.L., Potente H.: „Screw extrusion”, Carl Hanser Verlag, Munich 2003.

Received 14 V 2013.

SPEC 2014

Shedding New Light on Disease
17–22 August 2014, Krakow, Poland

The aim of this international conference series is to bring together clinicians and scientists who have joined forces in the quest for novel biomedical applications of Infrared and Raman spectroscopy to improve patient care.

Chair: Prof. Malgorzata Baranska (Jagiellonian University, Krakow)

Co-chair: Prof. Hugh J. Byrne (Focas Research Institute, Dublin)

Co-chair: Prof. Anna Sułkowska (Medical University of Silesia, Katowice)

Scientific Program: Contributions (presented either orally or as a poster) are invited in the fields related to applications of spectroscopic methods to the studies of:

- clinical applications,
- therapeutics,
- spectroscopic imaging technologies,
- in vivo and ex vivo diagnostics,
- in vitro screening,
- emerging technologies,
- per-processing methods and data analysis.

The programme will also include: special discussion session for young scientists and 1-minute presentation of poster presentation (for young scientists).

Registration:

30 April 2014 — deadline for early bird registration and fees

15 May 2014 — deadline for abstract submission

31 July 2014 — deadline for registration and fees

Conference fee includes conference materials, access to the lectures, poster session, coffee breaks, lunches, welcome cocktail, gala dinner, tourist programme.

Early bird: participants — 1900 PLN, PhD students — 1200 PLN, accompanying person — 1200 PLN, corporates — 2500 PLN

After 30 April 2014: participants — 2200 PLN, PhD Students — 1400 PLN, accompanying person — 1200 PLN, corporates — 3000 PLN

1-day (Monday only): participants/PhD students — 400 PLN

Conference Organizing Office: Targi w Krakowie Ltd., 31-586 Krakow, Poland, ul. Centralna 41a, phone: +48 12 651 90 45, e-mail: otwinowska@targi.krakow.pl

www.spec2014.com